

SPECIAL OPTION - 3 FILTER SHAKER MOTORS

AFTER JUNE 2021

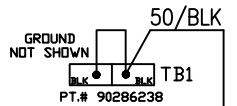

NOTE:
SET DIP SWITCHES
AS SHOWN

PT.# 748430

NOTE:
SET DIP SWITCHES
AS SHOWN

PT.# 748577

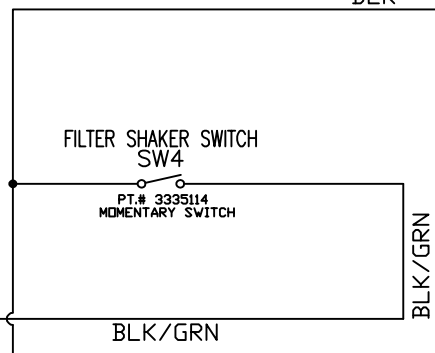
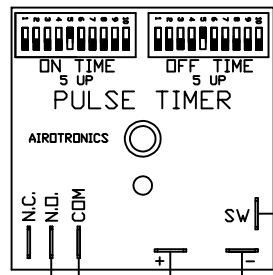
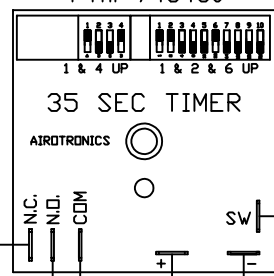

501
502
503
504
505
506
507
508
509
510
511
512
513
514
515
516
517
518
519
520
521
522
523
524
525
526
527
528

BLU/WHT

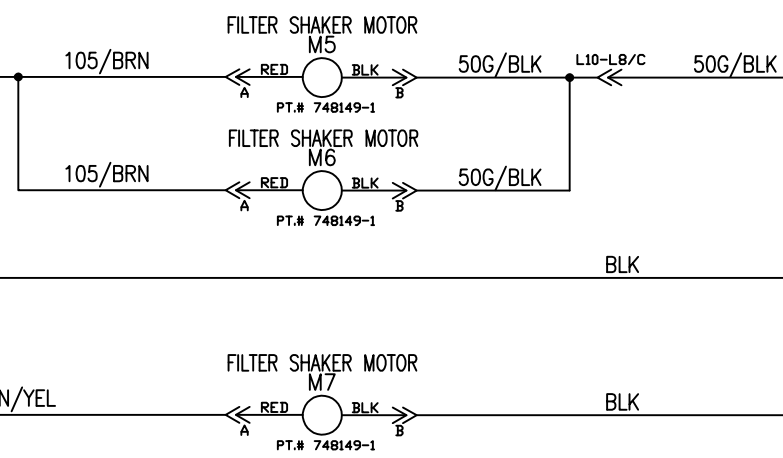
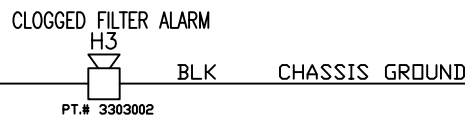
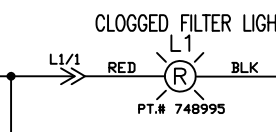
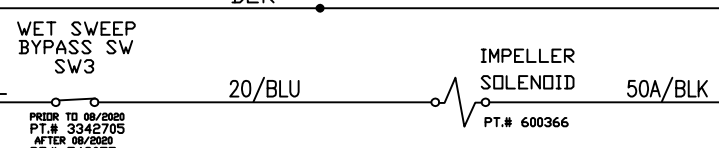
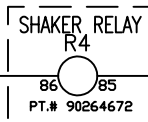
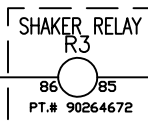
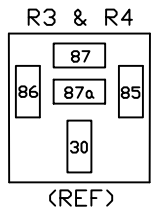

REV	ECN	DATE	DESCRIPTION	BY	ELECTRICAL DESIGN ENGINEER		DATE	PART NUMBER	REVISION	PAGE NUMBER
F	150479	11/19/18	UPDATE MERV FILTER & PT.#S	KHH			2/20/10	3397500	J	5 OF 5
G	151299	04/15/20	ADDED LOW LP AND FAN OPTION	KHH						
H	151500	12/11/20	UPDATE KEY, HORN SWITCH, SIDE LTS & GAS/LP	KHH						
J	151783	06/28/21	ADD NEW SHAKER OPTION SHEET 5	KHH						
					14N845 U.S. ROUTE 20 PINGREE GROVE, ILLINOIS 60140					
							CONFIDENTIAL THIS DRAWING AND ALL INFORMATION CONTAINED HEREIN ARE THE EXCLUSIVE PROPERTY OF MINUTEMAN INTERNATIONAL, INC. THIS DRAWING IS NOT TO BE COPIED OR OTHERWISE REPRODUCED WITHOUT EXPRESSED WRITTEN PERMISSION OF MINUTEMAN INTERNATIONAL, INC. IN ADDITION, THIS DRAWING MUST BE RETURNED UPON REQUEST. FURTHER, ALL INFORMATION CONTAINED HEREIN MUST BE MAINTAINED CONFIDENTIAL.	TITLE SCHEMATIC-ELECTRICAL ATLAS LP/GAS		